

HiFi ENGINE[®]

For more Hi-Fi manuals and set-up information
please visit www.hifiengine.com

Operating Instructions

AUDIO DIGITAL TIMER DT-550 DT-505

Thank you for buying this Pioneer product.

Please read through these operating instructions and then you will know how to operate your model properly. After you have finished reading the instructions, put them away in a safe place for future reference.

These operating instructions are based on the model KU, and they can be used for the KC, S, S/G models. The differences between the models are given below.

KU and KC models:

For U.S.A. and Canada ('KU' or 'KC' stamped on packing case): power line voltage is AC120 volts.

S and S/G models:

For destinations excluding above (S or S/G stamped on packing case); A 4-point (AC110V/120V/220V/240V) voltage selector switch is provided.

KU (for U.S.A.), KC (for Canada) models are not provided with LINE VOLTAGE SELECTOR and LINE FREQUENCY SELECTOR switch.



IMPORTANT NOTICE

The serial number for this equipment is located on the rear panel. Please write this serial number on your enclosed warranty card and keep in a secure area. This is for your security.

WARNING: TO PREVENT FIRE OR SHOCK HAZARD, DO NOT EXPOSE THIS APPLIANCE TO RAIN OR MOISTURE.

CONTENTS

Before Use	3	Dozing off to Sleep with Music	12
Application	4	Dozing off to Sleep with Music → Waking up to Music → Then Leaving Home	14
Connections	5	Handling Precautions	15
Front Panel Facilities	6	Specifications	16
Adjusting the Present Time	8		
Waking up to Music/Unattended Recording	10		

SAFETY INSTRUCTIONS [FOR KU MODEL]

READ INSTRUCTIONS – All the safety and operating instructions should be read before the appliance is operated.

RETAIN INSTRUCTIONS – The operating instructions should be retained for future reference.

HEED WARNING – All warnings on the appliance and in the operating instructions should be adhered to.

FOLLOW INSTRUCTIONS – All operating and use instructions should be followed.

WATER AND MOISTURE – The appliance should not be used near water – for example, near a bathtub, washbowl, kitchen sink, laundry tub, in a wet basement, or near a swimming pool, etc.

LOCATION – The appliance should be installed in a stable location.

WALL OR CEILING MOUNTING – The appliance should not be mounted to a wall or ceiling.

VENTILATION – The appliance should be situated so that its location or position does not interfere with its proper ventilation. For example, the appliance should not be situated on a bed, sofa, rug, or similar surface that may block the ventilation openings; or, placed in a built-in installation, such as a bookcase or cabinet that may impede the flow of air through the ventilation openings.

HEAT – The appliance should be situated away from heat sources such as radiators, heat registers, stoves, or other appliances (including amplifiers) that produce heat.

POWER SOURCES – The appliance should be connected to a power supply only of the type described in the operating instructions or as marked on the appliance.

POWER-CORD PROTECTION – Power-supply cords should be routed so that they are not likely to be walked on or pinched by items placed upon or against them, paying particular attention to cords at plugs, convenience receptacles, and the point where they exit from the appliance.

CLEANING – The appliance should be cleaned only with a polishing cloth or a soft dry cloth. Never clean with furniture wax, benzene, insecticides or other volatile liquids since they may corrode the cabinet.

POWER LINES – An outdoor antenna should be located away from power lines.

NONUSE PERIODS – The power cord of the appliance should be unplugged from the outlet when left unused for a long period of time.

OBJECT AND LIQUID ENTRY – Care should be taken so that objects do not fall and liquids are not spilled into the enclosure through openings.

DAMAGE REQUIRING SERVICE – The appliance should be serviced by Pioneer authorized service center or qualified service personnel when:

- The power-supply cord or the plug has been damaged; or
- Objects have fallen, or liquid has been spilled into the appliance; or
- The appliance has been exposed to rain; or
- The appliance does not appear to operate normally or exhibits a marked change in performance; or
- The appliance has been dropped; or the enclosure damaged.

SERVICING – The user should not attempt to service the appliance beyond that described in the operating instructions. For all other servicing, contact the nearest Pioneer authorized service center.

IMPORTANT [FOR KU MODEL]



The lightning flash with arrowhead, within an equilateral triangle, is intended to alert the user of the presence of uninsulated "dangerous voltage" within the product's enclosure that may be of sufficient magnitude to constitute a risk of electric shock to persons.

CAUTION

RISK OF ELECTRIC SHOCK
DO NOT OPEN

CAUTION:

TO PREVENT THE RISK OF ELECTRIC SHOCK, DO NOT REMOVE COVER (OR BACK). NO USER-SERVICEABLE PARTS INSIDE. REFER SERVICING TO QUALIFIED SERVICE PERSONNEL.



The exclamation point within an equilateral triangle is intended to alert the user of the presence of important operating and maintenance (servicing) instructions in the literature accompanying the appliance.

BEFORE USE

[EXCLUDING KU AND KC MODELS]

Before plugging the power cord into the wall socket, please confirm that the settings of the line voltage selector switch and line frequency selector switch are set correctly for use in your area. If they are not set properly, change the settings as follows.

LINE VOLTAGE SELECTOR SWITCH (Fig. A) [For S, S/G models only]

Before adjusting, disconnect the power cord.

1. Prepare a medium size screwdriver.
2. Insert the screwdriver into the arrow on the voltage selector and adjust so that the tip of the arrow points to the voltage value of your area.

LINE FREQUENCY SELECTOR SWITCH (Fig. B) [For S, S/G models only]

Set the switch to the position corresponding to the power line frequency (50 Hz or 60 Hz) used in your area. Remember that if this switch is not set properly, the time display of the clock function will be thrown out of sync.

If you do not know what the power line frequency in your area is, ask your dealer.

Only S and S/G models are provided with these switches but KU, KC are not provided with these switches.

REAR PANEL FACILITIES

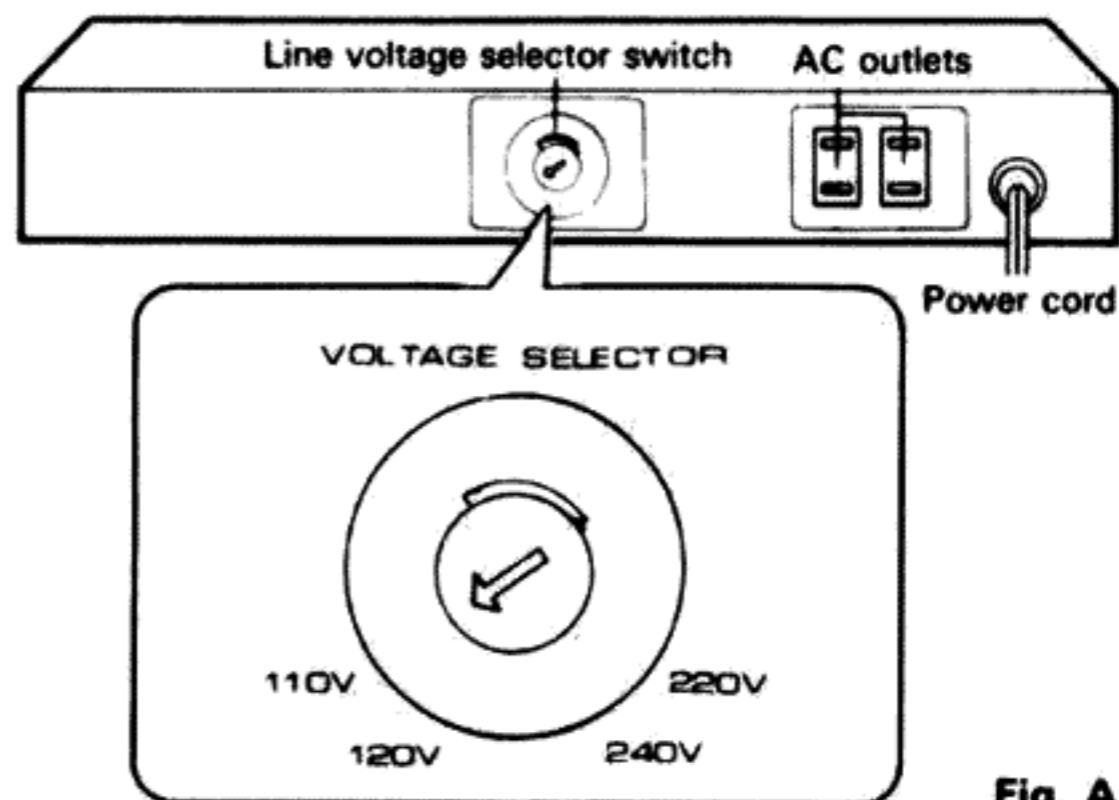

Fig. A

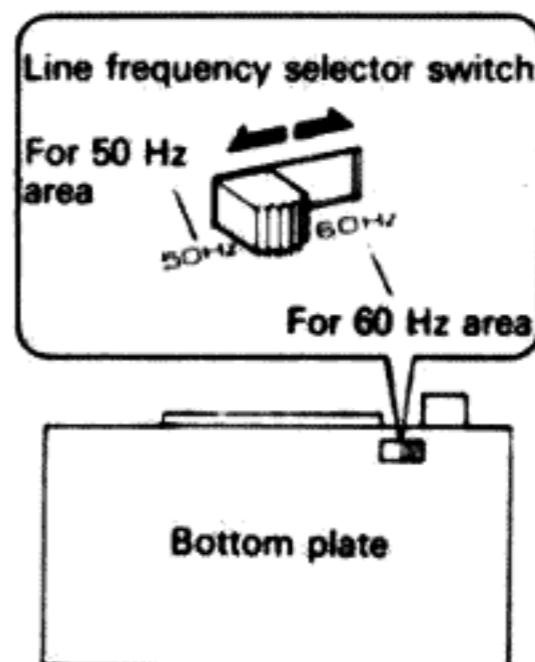

Fig. B

APPLICATION

■ Indicating the present time (hours, minutes & seconds) (See page 8.)

The present time is indicated in units of hours, minutes and seconds. If there has been a power failure while you were asleep or out, the time display will wink.



■ Waking up to music/unattended recording (See page 10.)

- When combined with the stereo equipment in your possession, the timer can play a radio program or tape at the desired time every day and then switch off the equipment also at the desired time.

Example: Waking up at 7:00 AM and leaving home at 8:00 AM

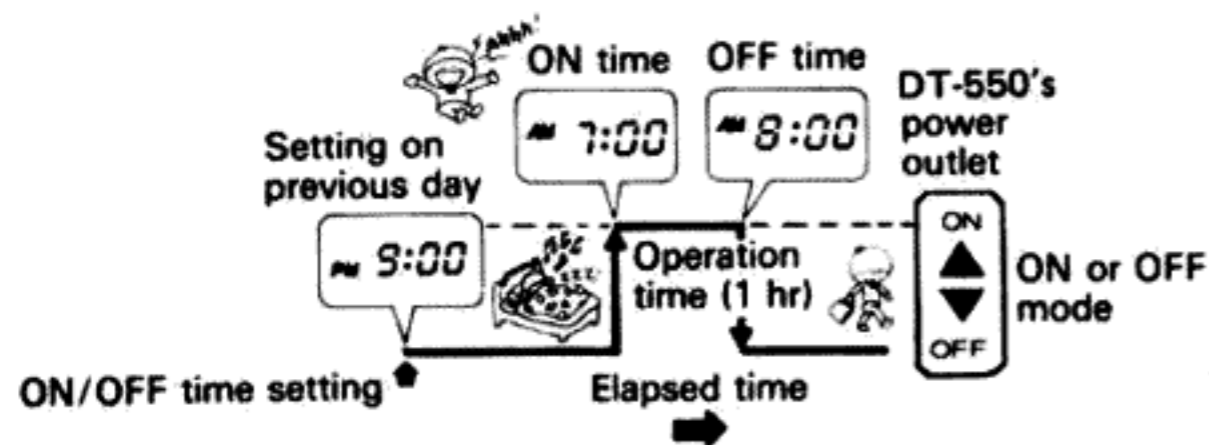

- When combined with the tape deck and tuner, the timer can record radio programs unattended.

Example: Recording programs unattended between 3:00 PM and 4:00 PM.

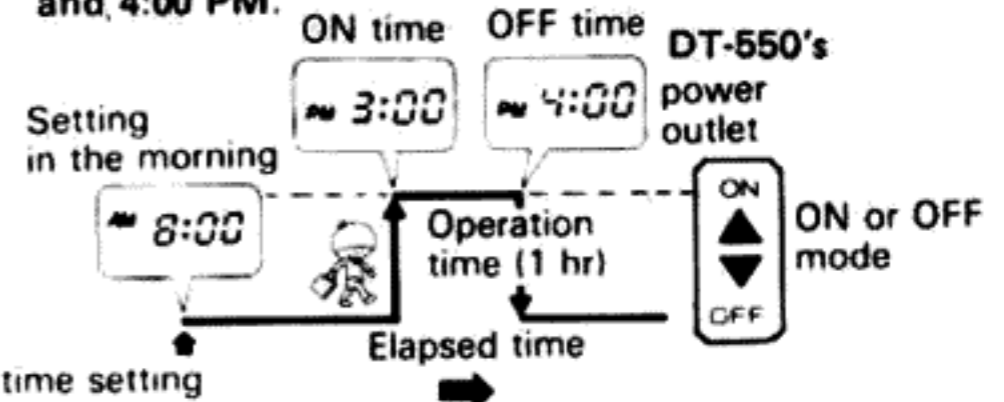

One ON and one OFF time can be set on the timer in a 24-hour period of time.

■ Dozing off to sleep with music (See page 12.)

You can use the sleep timer function to doze off to sleep while listening to your favorite music.

The time can be set between 1 minute and 1 hour 59 minutes.

Example: Sleeping after listening to music for 30 minutes.

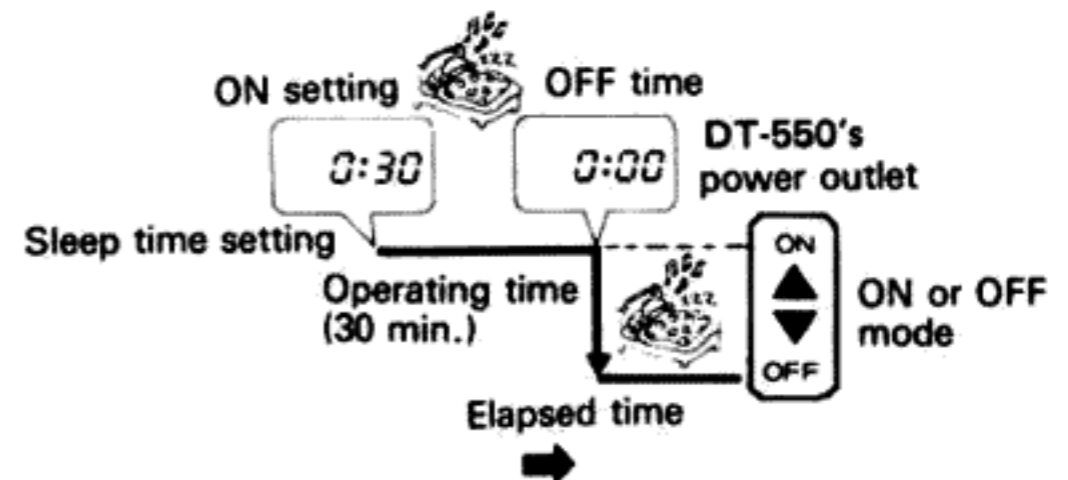

■ **Dozing off to sleep with music → waking up to music → then leaving home**
(See page 14.)

The sleep timer function and timer settings (ON/OFF times) can be used in combination.

Example: You go to bed at 10:00 PM while listening to music, the music is switched off at 10:30, you wake up the following morning to music at 7:00 AM and you leave home at 8:00.

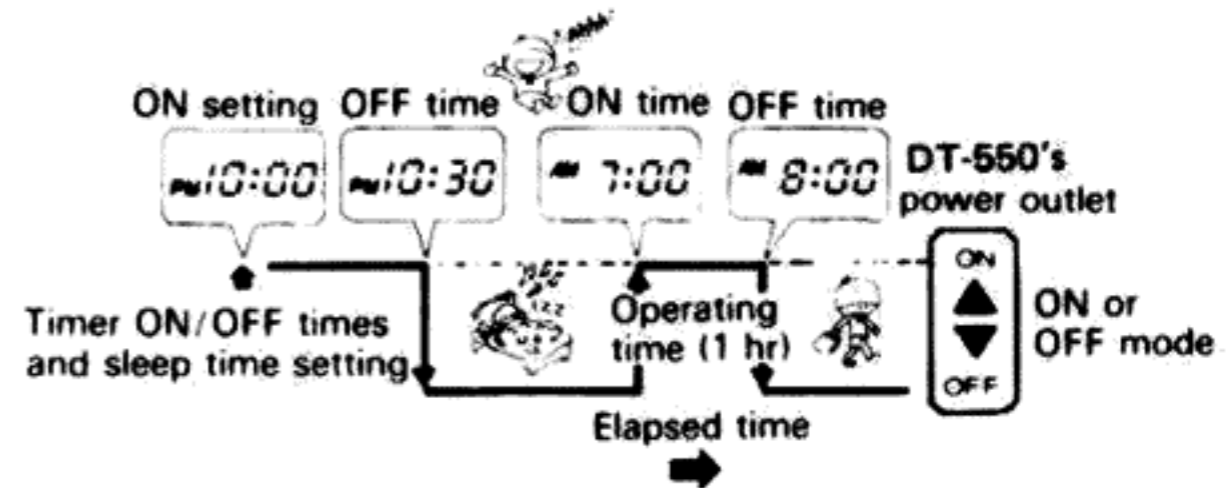

CONNECTIONS

PRECAUTIONS FOR CONNECTIONS

- As indicated in the figure, make sure that the total power consumption of all the audio components connected to the DT-550 does not exceed the power consumption indicated on the rear panel. For details on the power consumption specifications, refer to the Operating Instructions of the components concerned.
- High levels of current are prone to flow through audio components momentarily.
- Do not connect electrical appliances (such as TV sets) in which high levels of current are prone to flow at the instant when the power switch is set to ON.
- Do not connect electrical appliances (such as irons, heaters, air conditioners) whose power consumption exceeds the indicated value since this may result in a fire or malfunction.

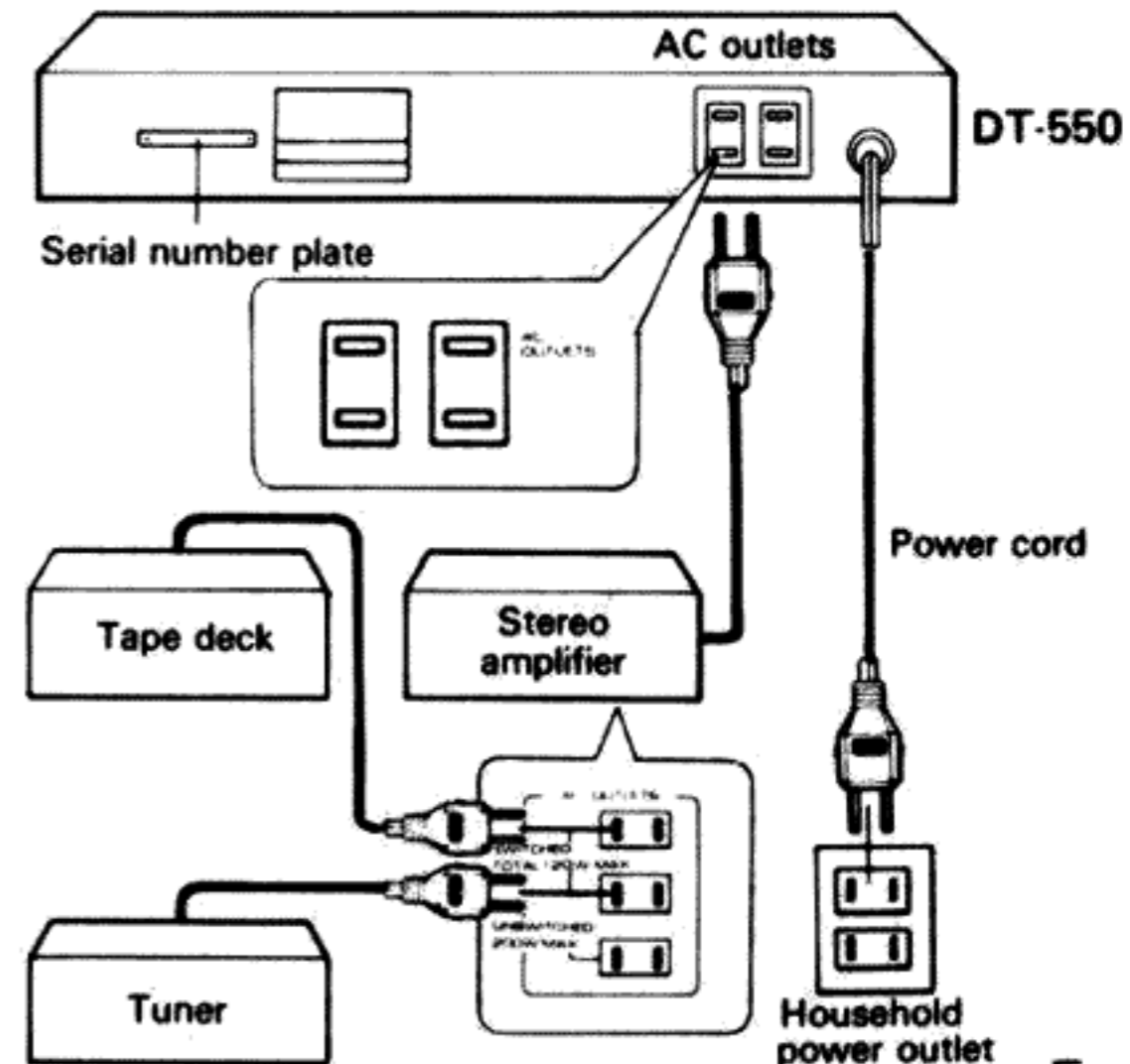

FRONT PANEL FACILITIES

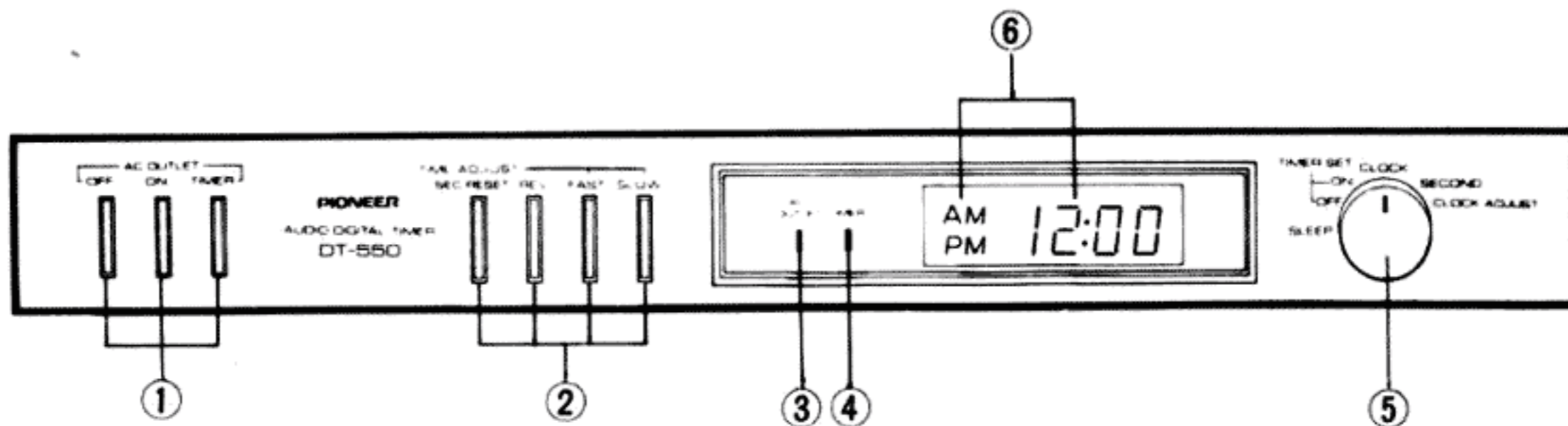

① AC OUTLET SELECTORS

These switch on and off the power flowing to the rear panel AC outlets.

OFF: Used to switch off the power of the connected audio components regardless of the timer operation (set times).

ON: Used to switch on the power of the connected audio components regardless of the timer operation (set times).

TIMER: Used to switch ON and OFF the power of the connected audio components with the timer operation.

② TIME ADJUST SWITCHES

These are used to adjust the time/displayed times in line with the setting of the mode selector.

SEC RESET: When this switch is depressed with the mode selector in the SECOND position, the second

display of the present time is reset to **■:00** and when released the seconds are counted up from **■:00** → **■:01** → **■:02** → etc., and the rightmost minute digit and seconds are displayed.

REV: When the FAST or SLOW switch is depressed while this switch is in the depressed position, the displayed time is reversed rapidly or slowly. (This function does not work when the sleep timer function is set.)

FAST: When this switch is depressed, the displayed time is forwarded rapidly.

SLOW: When this switch is depressed, the displayed time is forwarded slowly.

③ AC OUTLET INDICATOR (red)

This lights when power is being supplied to the AC OUTLETS on the rear panel.

④ TIMER INDICATOR (green)

This lights when the AC OUTLET-TIMER selector is depressed.

⑤ MODE SELECTOR

This is used to select the timer's function.

SLEEP: Used to set the operating time (1 minute to 1 hour 59 minutes) until the power of the audio components operating is to be set OFF.

TIMER SET-OFF: Used to set the time at which the power to the connected audio components is set OFF.

TIMER SET-ON: Used to set the time at which the power to the connected audio component is set ON.

CLOCK: Used to display the present time (hours & minutes).

SECOND: Used to adjust the seconds of the present time and check the seconds of the present time.

CLOCK ADJUST: Used to adjust the clock to the present time.

⑥ TIME DISPLAY

The time is displayed as it relates to the mode selector or TIME ADJUST switch settings in the following table.

Mode selector	TIME ADJUST switch	Display	Example of display
SLEEP	FAST SLOW	Time until sleep operation is due to go OFF.	1:30 1 hr 30 min.
TIMER SET-OFF	FAST SLOW REV	Display of OFF time set by timer.	AM 8:00 AM 8 hr 00 min.
TIMER SET-ON	FAST SLOW REV	Display of ON time set by timer	AM 7:30 AM 7 hr 30 min.
CLOCK	—	Display of present time	PM 5:38 PM 5 hr 38 min.
SECOND	—	Display of seconds and rightmost digit of present time minute	8:25 8 min. 25 sec.
	SEC RESET	Display for adjusting seconds correctly of present time	5:00 5 min. 00 sec.
CLOCK ADJUST	FAST SLOW REV	Display for adjusting hours and minutes of present time	PM 12:05 PM 12 hr 5 min.

NOTE:

When the unit's power plug is connected to a household AC outlet, the "AM 12:00" or "0:00" time display will wink. It also winks when there has been a power failure while the unit was working and the power has been restored.

ADJUSTING THE PRESENT TIME

Example: Adjusting the time to AM 8:35:00

The DT-550 clock comes with a second display. This makes it possible to adjust the time down to the last second in synchronization with the radio, TV or telephone time signal.

- 1 Plug the timer's power cord into the household AC outlet.**

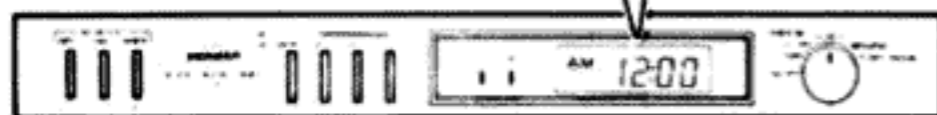
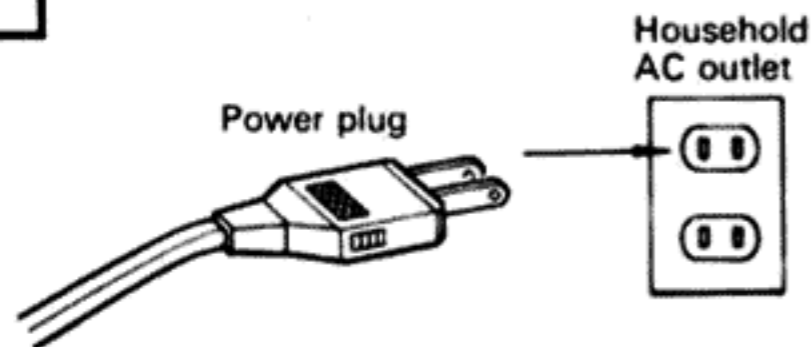

- When "AM 12:00" or "0:00" winks during use, the present time, timer ON/OFF set times and sleep time are released. Set these times again.

- 2 Set the present time (hours & minutes).**

- Set the mode selector to CLOCK ADJUST.

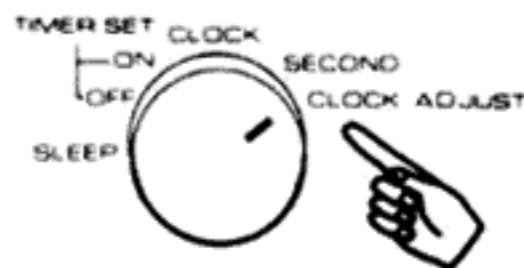

- Depress the TIME ADJUST-FAST switch until just before the present time (8:30 AM) and then release the switch.
- Depress the SLOW switch and adjust to 8:35 AM.
- If the present time is exceeded, depress the SLOW switch together with the REV switch to reverse the time.



"AM" indicates the morning time and "PM" the afternoon and evening time. "PM 12:00" is midday while "AM 12:00" is midnight.

3 Reset the seconds of the present time to 00 sec.

No matter what the time is, the seconds can be set with the 00 sec. time signal. Example: 5 min. 00 sec.

- Set the mode selector to SECOND.



- Depress the TIME ADJUST-SEC RESET switch and wait until the time signal is heard.
- Release the switch as soon as the time signal is heard.

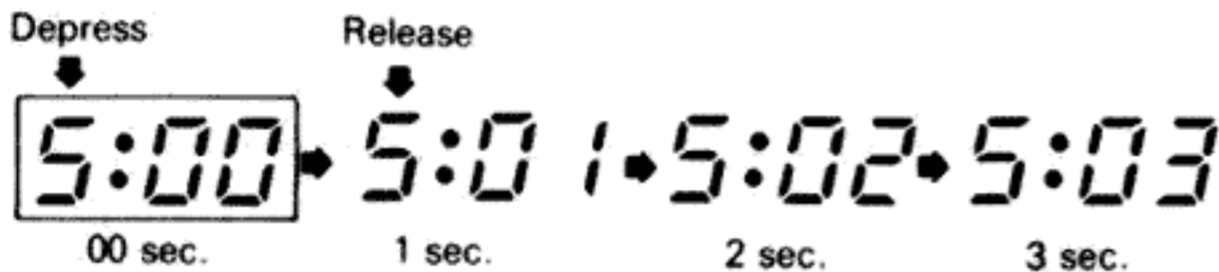
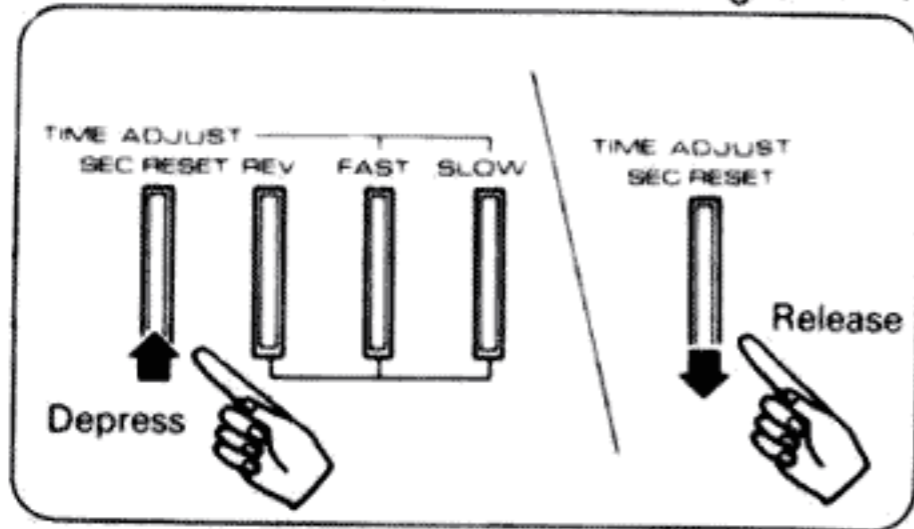

4 Set the mode selector to CLOCK.

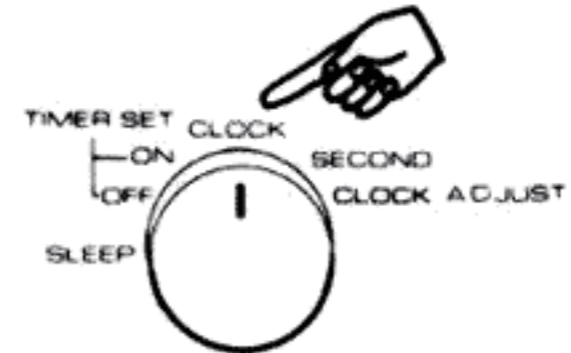

The present time is now displayed.



WAKING UP TO MUSIC/UNATTENDED RECORDING

Example: Waking up at AM 7:00 (switch ON) & leaving for work at AM 8:00 (switch OFF)

- This timer can be used to switch on the power to the connected audio components and switch off the power at the desired times.
- It is possible to set one ON time and one OFF time in a 24-hour period (1 day).
- As long as the AC OUTLET-TIMER selector is depressed (the TIMER indicator is on), the ON/OFF times will be operative every day.
- For unattended recording, use a tape deck with a built-in unattended recording standby mechanism.

PREPARATIONS

- Depress the AC OUTLET-ON selector.
- **For waking up to music:** Operate the stereo amplifier and tuner or tape deck and prepare them for radio reception or tape play.
- **For unattended recording:** Operate the stereo amplifier and tuner and tune in the desired station. Set the tape deck up for unattended recording. For details, refer to the Operating Instructions of the tuner and tape deck.

NOTES:

- *The timer's ON/OFF times cannot be set in second units.*
- *It is not possible to set the timer ON time and not the OFF time (or vice versa). Be sure to set the ON time first and then the OFF time.*

TIMER ON/OFF SET TIME OPERATIONS

1

Set the time (7:00 AM) at which the power is to come ON.

- Set the mode selector to TIMER SET-ON.



- Depress the TIME ADJUST-FAST switch until just before the desired time (AM 6:50) and then release the switch.
- Depress the SLOW switch and set to AM 7:00.
- If the desired time is exceeded, depress the SLOW switch together with the REV switch

2

Set the time (8:00 AM) at which the power is to go OFF.

- Set the mode selector to TIMER SET-OFF.



- As with the ON time setting, depress the FAST or SLOW switch together with the REV switch and set the time to AM 8:00.

3**Check the desired operating times.**

- Set the mode selector to the **TIMER SET-ON** and **TIMER SET-OFF** positions and check the operating times (ON and OFF) set under steps 1 and 2.

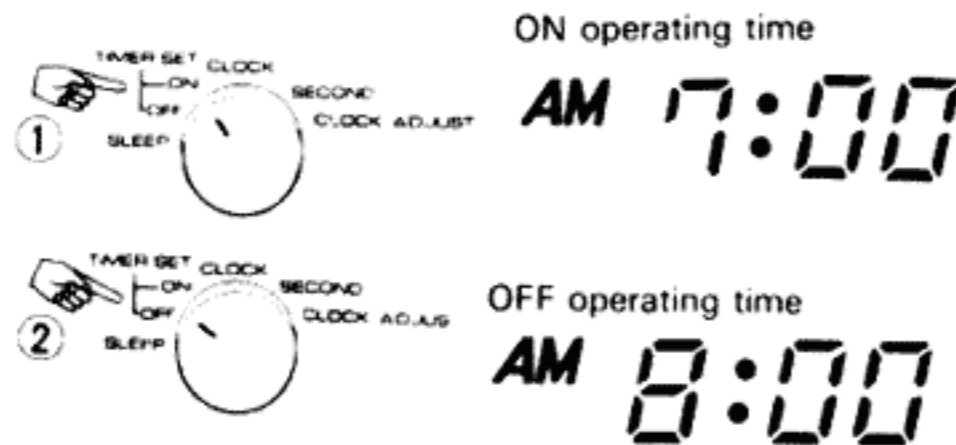

ON operating time

AM 7:00

OFF operating time

AM 8:00

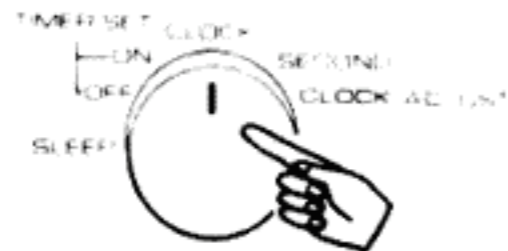
4**Return the mode selector to the **CLOCK** position.**

- The present time is now displayed although the set operating times have been memorized.

5**Depress the **AC OUTLET-TIMER** selector.**

- The **TIMER** indicator lights.
- The power to the connected audio components will now come ON at 7:00 AM and go OFF at 8:00 AM.

**NOTES:**

- Depress the **AC OUTLET-OFF** selector when you want to switch off the power earlier than the set **OFF** time with audio components which have become operational at the timer **ON** time. In this case, power will not be supplied again to the audio components even when the **AC OUTLET-TIMER** selector is depressed.
- Starting from the following day (after 24 hours), the power will be switched on at the **ON** set time and switched off at the **OFF** set time.
- If the components come **ON** while the timer's **ON** and **OFF** times are being set, depress the **AC OUTLET-OFF** selector and perform the timer settings again.
- If the mode selector is at **SLEEP**, the power to the connected audio components will not be switched on even at the timer **ON** time.

CHANGING THE TIMER'S ON/OFF TIMES

Set the times again following the procedure in steps 1 through 5. The previously set times will be erased and replaced by the new set times.

DOZING OFF TO SLEEP WITH MUSIC

Example: Dozing off to sleep while listening to music and having the power switched off after 1 hr 30 min have elapsed.

The time which will elapse until the power is switched off can be adjusted between 1 minute and 1 hour 59 minutes when you are dozing off to a radio program or tape play.

PREPARATIONS

- Depress the AC OUTLET-ON selector.
- Operate the stereo amplifier and tuner or tape deck and set up the components for radio reception or tape play.

SLEEP TIMER OPERATIONS



Set the time until the power is to be switched OFF.

- Before setting the sleep timer, first check the timer's ON and OFF time.
- Set the mode selector to SLEEP.



- Operate the FAST and SLOW switches and set the desired time (example: 1 hr 30 min.) which is to elapse before the power is to be switched OFF, as shown in the table below.

Operation	Display during operation	Set time
When the FAST or SLOW switch is depressed, the display changes as on the right.	<div style="display: flex; align-items: center; gap: 10px;"> 0:00 → 1:59 → 1:58 → 1:57 → </div>	Release switch as soon as desired time is displayed. <div style="text-align: center; margin-top: 10px;"> 1:30 </div>

NOTE:

The REV does not work at the SLEEP position.

2 Depress the AC OUTLET-TIMER selector.

- The timer indicator lights.

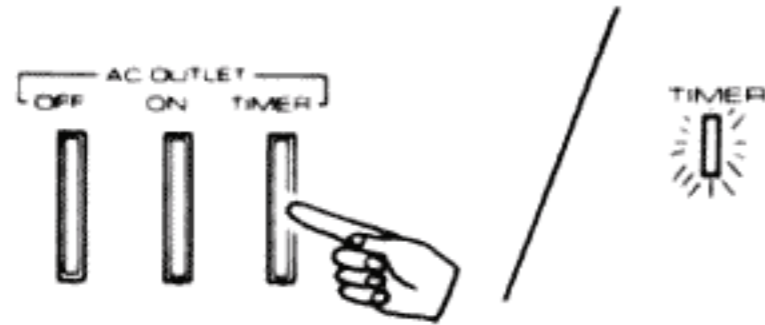

When 1 hour and 30 minutes have elapsed, the power to the connected audio components is switched off.

Elapsed time Power is OFF

1:30 • 1:29 • 1:28 ••••• 0:00

NOTE:

When the power is to be switched off earlier than the timer OFF time during the sleep timer operation, depress the AC OUTLET-OFF selector. In this case, the timer ON/OFF operations are not effective.

3 Return the mode selector to CLOCK.



The present time is displayed.

WHEN CHECKING THE TIME REMAINING

The time remaining is displayed when the mode selector is set to SLEEP. After checking, remember to return the selector to the CLOCK position.

DOZING OFF TO SLEEP WITH MUSIC → WAKING UP TO MUSIC → THEN LEAVING HOME

The sleep timer function and timer ON/OFF set function can be used together for this operation.

PREPARATIONS

- Depress the AC OUTLET-ON selector.
- Operate the stereo amplifier and tuner or tape deck and set up the components for radio reception or tape play.

STEPS FOR OPERATION

Set the timer's ON/OFF times first.

- 1** Set the time at which the power is to come ON to wake you up with music.

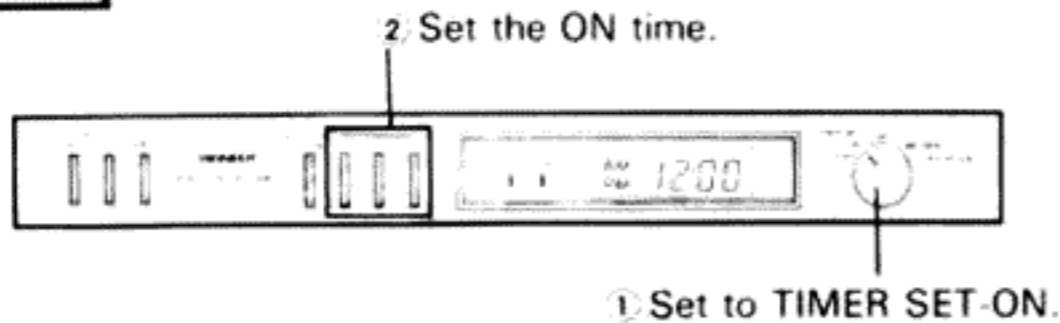

- 2** Set the time at which the power is to go OFF.

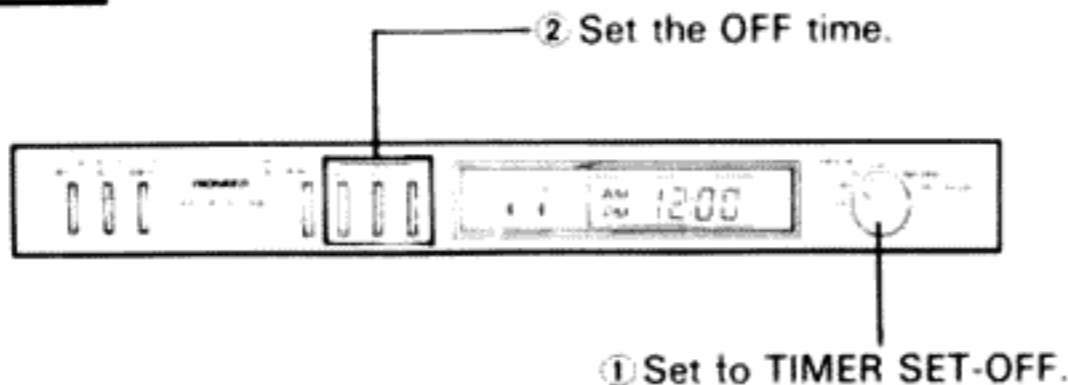

Next, set the sleep timer function.

- 3** Set the time which is to elapse until the power is to go OFF after you have dozed off while listening to music.

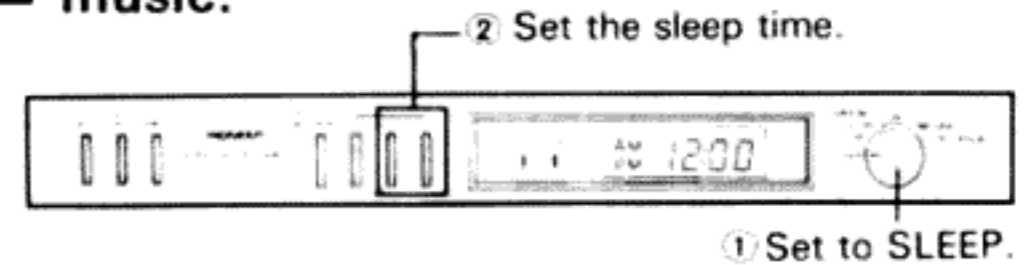

- 4** Depress the AC OUTLET-TIMER selector.

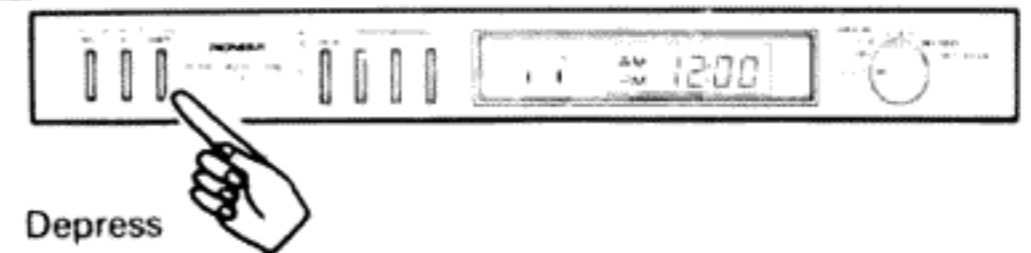

- 5** Return the mode selector to the CLOCK position.

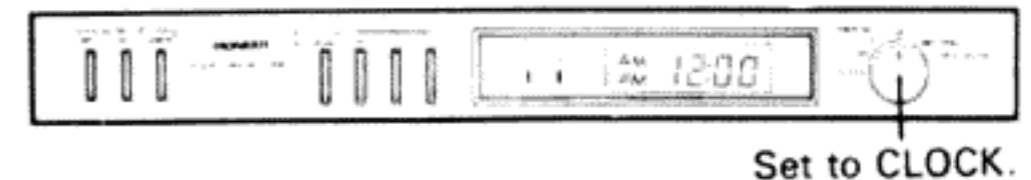

NOTE:

Keep the mode selector at the SLEEP position if you do not want to be woken up to music on the following morning but simply want to doze off to sleep with music.

In cases like this, "0:00" is displayed in the SLEEP mode without the time being indicated.

HANDLING PRECAUTIONS

Keep the unit away from water

Electric shocks and malfunctions are caused by water penetrating inside the timer. Do not stand vases or other objects containing water on top of the timer. If water does happen to get inside the unit, disconnect the power cord from the power outlet immediately.

Then contact your nearest Pioneer Service Center or the dealer from whom you bought your unit.

Do not poke about inside the unit

Under no circumstances should the screws around the casing be removed since this may lead to an electric shock. Do not try to remove the casing to inspect inside or make adjustments. Pioneer can make no guarantees in the case of a deterioration in performance resulting from remodeling by a user.

Avoid use in hot (over 45°C) and cold (under -5°C) locations

Also avoid using the timer in a location susceptible to vibration since this may cause a time error.

Maintenance

Use a soft dry cloth for usual cleaning. If there are stains which cannot be removed, dilute some neutral detergent with water, dip a cloth into the solution and wipe away the stains. Never use alcohol, thinners or benzene for cleaning or spray insecticides near the unit since these substances may mar the model's finish.

If the timer makes any buzzing or rattling noise during use, disconnect the power cord from the power outlet and contact the nearest Pioneer Service Center or the dealer from whom you bought your unit.

SPECIFICATIONS

Time display	Digital display with fluorescent display tube
Timer type	24-hour type (AM/PM, 12-hour display)
Timer setting	Only one ON/OFF time setting in minimum units of minutes within a 24-hour period
Sleep timer	Setting in minimum units of minutes up to 1 hour 59 minutes
Time accuracy	Synchronized with line frequency
Timer accuracy	Within ± 0.1 sec. of time displayed
Sleep timer accuracy	Within 59 sec. of set time

Power section, others

Power requirements KU, KC model	AC 120 V 60 Hz
S, S/G model . . .	AC110V/120V/120V/240V (switchable) 50Hz/60Hz (switchable)
AC outlets: Total of 2 outlets,	
DT-550/KU, KC models; 500W (Inductive load)	
DT-550/S, S/G models; 1200W	
DT-505/S model; 500W (Inductive load)	
Power consumption	6W

Other functions

- AC OUTLET "on" display (red LED lights)
- Timer operation display (green LED lights)
- Power failure display (time display winks)

Dimensions

420 (W) x 52 (H) x 144 (D) mm
16-9/16 (W) x 2-1/16 (H) x 5-11/16 (D) in

Weight 1.7 kg (3 lb 12 oz)

Accessories

Operating Instructions 1

NOTE:

Specifications and design are subject to possible modification without notice due to improvements.

[For KC model]

CAUTION: TO PREVENT ELECTRIC SHOCK DO NOT USE THIS (POLARIZED) PLUG WITH AN EXTENSION CORD, RECEPTACLE OR OTHER OUTLET UNLESS THE BLADES CAN BE FULLY INSERTED TO PREVENT BLADE EXPOSURE.

ATTENTION: POUR PREVENIR LES CHOCS ELECTRIQUES NE PAS UTILISER CETTE FICHE POLARISEE AVEC UN PROLONGATEUR UNE PRISE DE COURANT OU UNE AUTRE SORTIE DE COURANT, SAUF SI LES LAMES PEUVENT ETRE INSEREES A FOND SANS EN LAISSER AUCUNE PARTIE A DECOUVERT.

PIONEER ELECTRONIC CORPORATION 4-1, Meguro 1-Chome, Meguro-ku, Tokyo 153, Japan

PIONEER ELECTRONICS [USA] INC. P.O. Box 1760, Long Beach, California 90801 U.S.A.

TEL: [800] 421-1404, [213] 420-5914

PIONEER ELECTRONIC [EUROPE] N.V. Keetberglaan 1, 2740 Beveren, Belgium TEL: 03/775 28 08

PIONEER ELECTRONICS AUSTRALIA PTY. LTD. 178-184 Boundary Road, Braeside, Victoria 3195, Australia

TEL: [03] 580-9911